

KORAS CP50.13

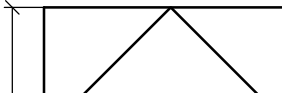

+0.000

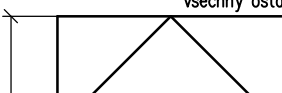
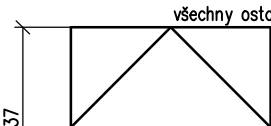
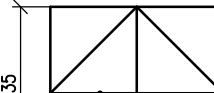
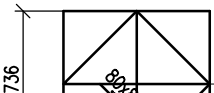
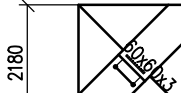
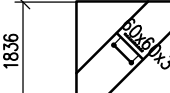
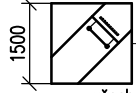
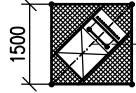
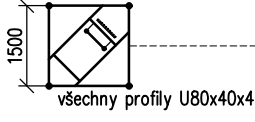
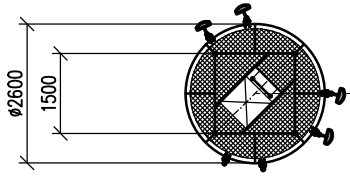
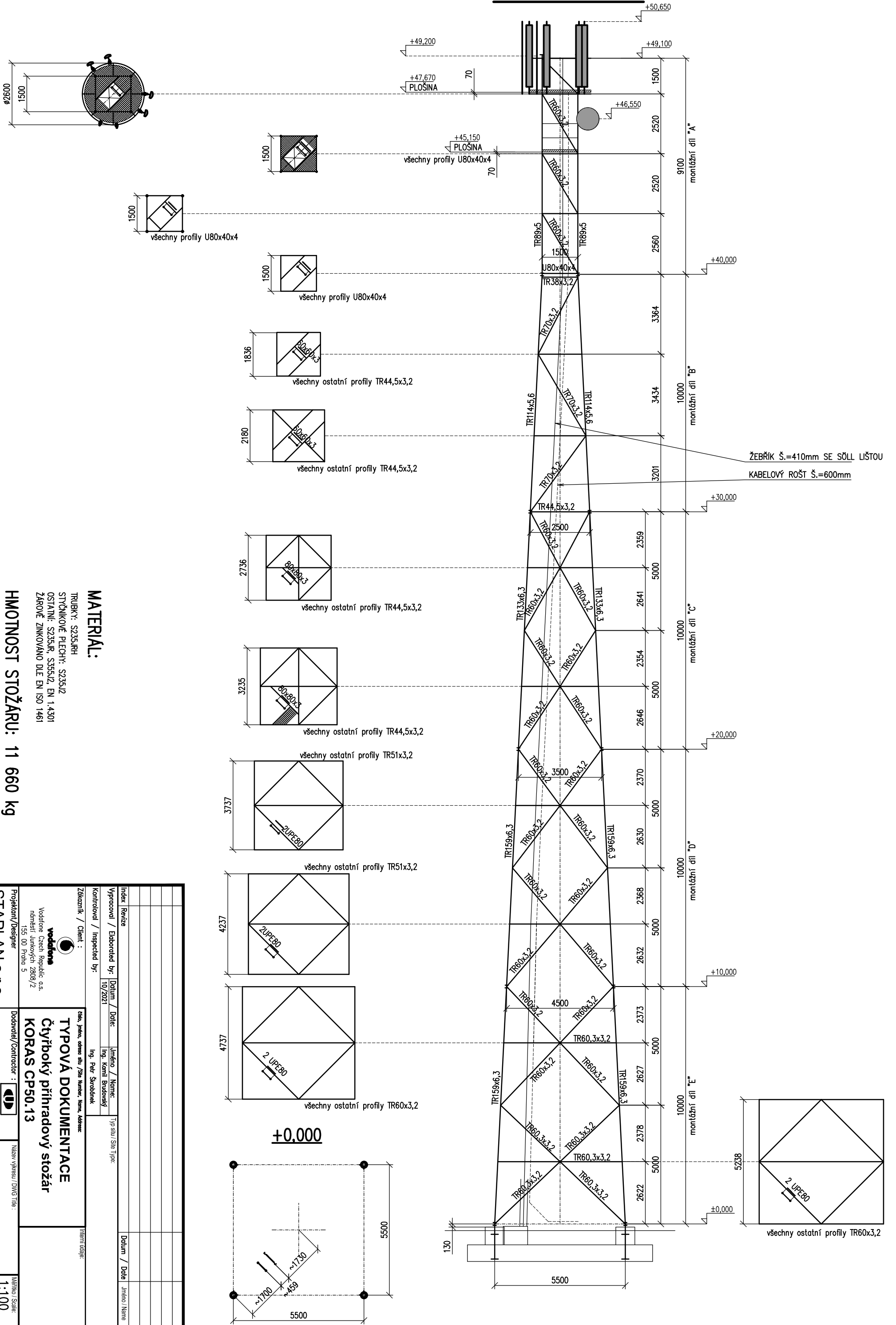
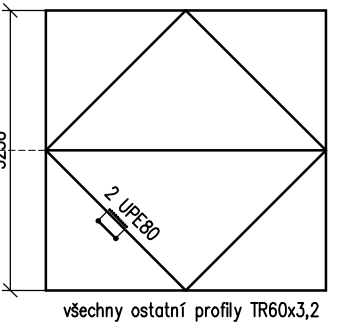
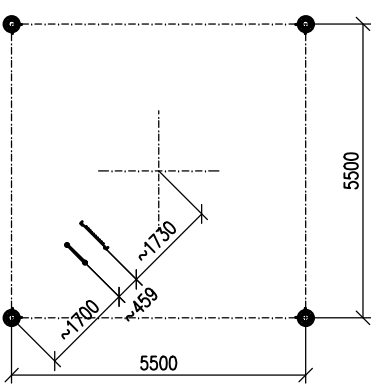

MATERIAL:
 TRUBKY: S235JRH
 STYČKOVÉ PLECHY: S235J2
 OSTATNÍ: S235JR, S355J2, EN 1.4301
 ŽÁROVĚ ZINKOVANO DLE EN ISO 1461

HMOTNOST STOŽÁRU: 11 660 kg

Index	Revize	Vypracoval / Elaborated by:	Datum / Date:	Jméno / Name:	Typ sítě / Site Type:	Datum / Date	Jméno / Name
			10/2021	Ing. Kamil Brádovský			
Kontroloval / Inspected by:							
Ing. Petr Štroubánek							
Zdávající / Client:		Číslo, jméno, adresa stavby / Site Number, Name, Address:					
<p>vodárna Vodárna České republiky a.s. náměstí Juhových 2808/2 155 00 Praha 5</p>		TYPOVÁ DOKUMENTACE Čtyřboký příhradový stožár KORAS CP50.13					
Projektant / Designer: STAPLAN s.r.o. SOUKKEMNICKÁ 877/9 702 00 OSTRAVA		Dodavatel / Contractor: KORAS Trade KORAS Trade s.r.o. SOUKKEMNICKÁ 877/9 702 00 OSTRAVA		Název výřezu / DWG Title:		Měřítko / Scale: 1:100 Číslo výřezu	